



# HOSHIZAKI

## CERTIFICATION



HACCP International



ISO9001

## FM-480AKS-HCN-SB-B-301SA

### NUGGET ICE MAKER



## Key Features



NATURAL  
REFRIGERANTS

**Eco-Friendly  
Refrigerant**



**Easy for maintenance**  
Notify when parts should  
be replaced

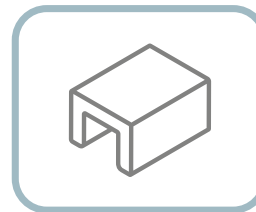

**Stainless Steel  
Exterior**

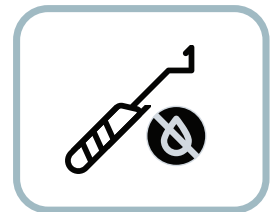

**Stainless Steel &  
Greaseless Auger**

Our Flake & Nugget Ice Makers belong to the true allrounders of the Hoshizaki product line-up. These powerful, durable and sustainable machines are highly popular across different market segments, such as in food preparation / processing, as well as in hotels, bars, restaurants and catering businesses.



# Dimensions & Specifications

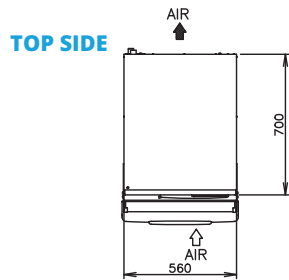

## NUGGET ICE AIR SYSTEM

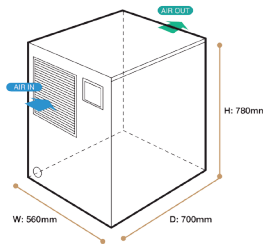

## ICE SHAPE

### NUGGET Compressed Flake Ice

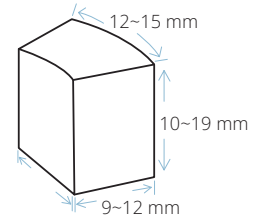

## FRONT SIDE

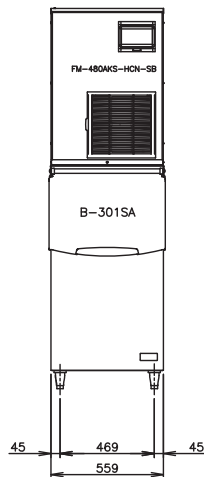

## RIGHT SIDE

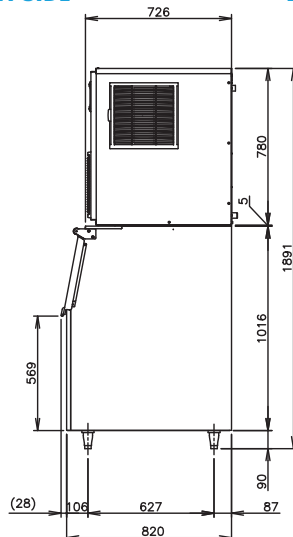

## BACK SIDE

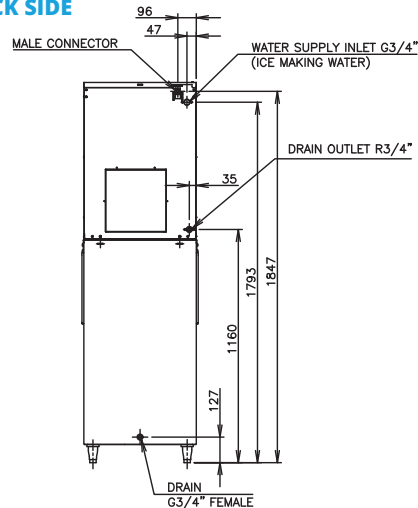

MODEL		FM-480AKS-HCN-SB-B-301SA
ICE SHAPE		Nugget Ice
POWER SUPPLY		1 Phase 220-240V 50Hz Capacity: 1.80kVA (5.8A)
AMPERAGE		5.8A Started: 30A
ELECTRIC CONSUMPTION		1200W
HEAT REJECTION	(AT32°C / WT21°C)	2200W
ICE PRODUCTION PER 24H	(AT10°C / WT10°C)	395kg
	(AT21°C / WT15°C)	337kg
	(AT32°C / WT21°C)	276kg
STORAGE CAPACITY		Approx. 144kg
WATER CONSUMPTION PER 24H	(AT32°C / WT21°C)	278L
CONTAINER TYPE		Ice bin is not included
REFRIGERANT		R290 / 125g
OUTSIDE DIMENSIONS		560mm(W) x 820mm(D) x 1891( - 1921)mm(H)
PACKAGE		Ice Maker: Carton: 665 x 820 x 950mm Storage Bin: Carton: 655 x 924 x 1188mm
WEIGHT		Ice Maker: 92kg / 99kg Storage Bin: 37kg / 49kg
OPERATING CONDITIONS		Ambient Temp.:5-40°C, Water Supply Temp.:5-35°C, Water Supply Pressure: 0.05-0.8MPa, Voltage Range: Rated Voltage±10%



# HOSHIZAKI

**HOSHIZAKI MALAYSIA SDN. BHD.**

No. 12, Jalan Penyajak U1/45B, Hicom-Glenmarie  
Industrial Park, 40150 Shah Alam, Selangor  
TEL (+60) 3 5569 8023 <https://hoshizaki.com.my/>

